

ASSEMBLED VIEW

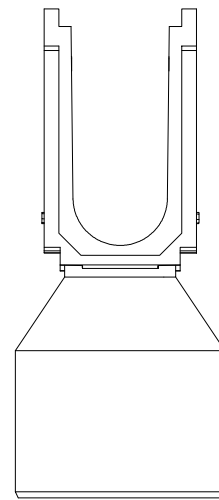

END VIEW

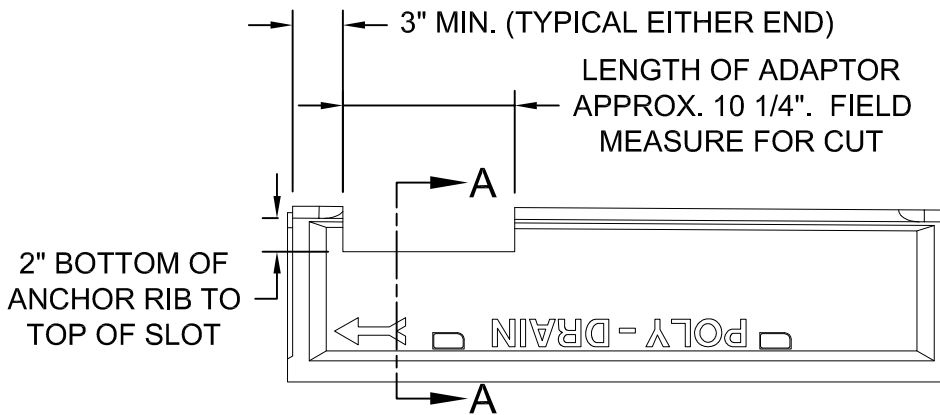

**CHANNEL MODIFICATIONS
FOR Ø8" PVC ADAPTOR**

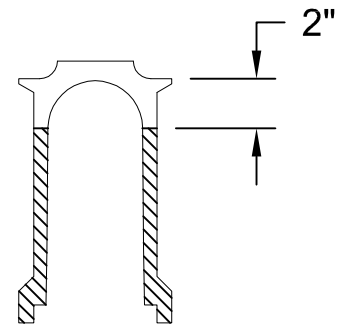

SECTION A-A

NOTES:

1. Cut opening in bottom of channel per "CHANNEL MODIFICATIONS" Diagram above using typical masonry equipment.
2. Set PVC ADAPTOR into opening in MODIFIED CHANNEL.
3. Center HANGER STRIP in opening and against top surface of ANCHOR RIB.
4. Insert HANGER SCREW through hole in HANGER STRIP and drive screw into PVC ADAPTOR. Repeat for all screws. Cut screw penetrating PVC ADAPTOR as required after installation.
5. Caulk or tape over any openings between PVC ADAPTOR and CHANNEL as required to control concrete leakage.
6. Locate and align assembled unit in trench and connect piping.



P.O. BOX 837, 259 MURDOCK ROAD
TROUTMAN, NC 28166
(704) 528-9806

SPECIFICATION DRAWING © 2007 ABT, Inc.

**Ø8" PVC Pipe Adaptor
Installation Instructions**

FILE: **S-2832**

PART: **2832**

Proprietary rights of ABT, Inc. are included in the information disclosed herein. The recipient, by accepting this document, agrees that neither this document nor the information disclosed herein nor any part thereof shall be copied, reproduced or transferred to others for manufacturing or for any other purpose except as specifically authorized in writing by ABT, Inc.

DISCLAIMER : The customer and the customer's architects, engineers, consultants and other professionals are completely responsible for the selection, installation, and maintenance of any product purchased from ABT, and EXCEPT AS EXPRESSLY PROVIDED IN ABT'S STANDARD WARRANTIES, ABT MAKES NO WARRANTY, EXPRESS OR IMPLIED, AS TO THE SUITABILITY, DESIGN, MERCHANTABILITY, OR FITNESS OF THE PRODUCT FOR CUSTOMER'S APPLICATION. Copies of ABT's standard warranties are available upon request.